

Dot laser, green, 532 nm, 25 mW

DJ532-25-3(20x80)
Order Number: 70102352

Main Parameters (*)	min	typ	max	Unit
Wavelength		532		nm
Optical Output Power		25		mW
Operating Voltage	2.7	3	3.3	V DC
Operating Current		370		mA
Operating Temperature	15		30	°C
Storage Temperature	-40		80	°C

Main Data

Warranty 1 years

Technical Parameters

Lifetime > 5,000 h
RoHS yes

Optical Parameters

Beam Shape	Dot
Laser Class	3B
Divergence	J - 2.0 mrad
Beam Diameter	0.15 mm
Size of Laserdot	0.15mm@10mm
Operating Distance	15 m
Optics	glass lens AR coated
Beam Mode	TEM00
Laser technology	YVO4+KTP
Protection Lens	no
Focus	collimated
Warm up time	< 15 min

Electrical Parameters

Potential of Housing isolated

Mechanical Parameters

Size	Ø20x80 mm
Material	aluminium
Cable length	100 mm
Output Aperture	5 mm
Weight	55 g

(*) Over the complete operating temperature range

Features



Picture



Cable color

Ground		blue	GND
Positive		red	2.7 - 3.3, typ 3 V DC

Drawing

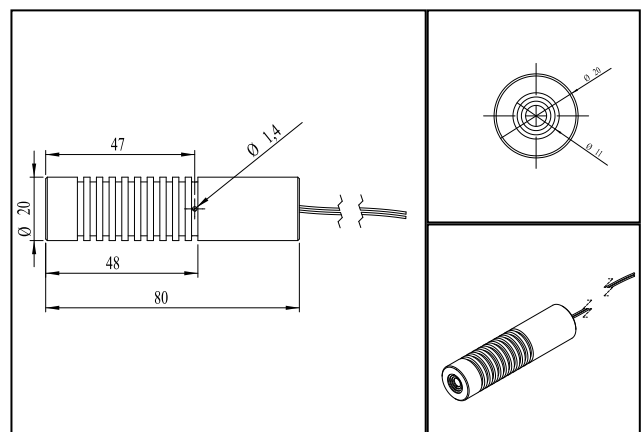

Safety Label



Valid Revision

3 | 07-FEB-2019